

POWER RESISTOR – PR

FEATURES



- Metal film technology
- Non-flammable
- High power in small package
- High stability, reliability and uniformity characteristics
- Good performance for pulse applications
- Defined interruption behavior (fusing time)
- Different leads for different applications
- Various forming styles



QUICK REFERENCE DATA

DESCRIPTION	PR01		PR02		PR03	
	Resistance range	0.22Ω - 1MΩ	1Ω - 1MΩ	0.33Ω - 1MΩ	1Ω - 1MΩ	0.33Ω - 1MΩ
Tolerance and series	±5%, E24	±1%, E24/E96	±5%, E24	±1%, E24/E96	±5%, E24	±1%, E24/E96
Maximum dissipation at $T_{amb.} = 70^{\circ}C$	1W		2W		3W	
Limiting voltage (DC or RMS)	350V		500V		750V	
Rated voltage ⁽¹⁾	$\sqrt{P_n \times R}$					
Temperature coefficient	±250ppm/°C					
Basic specification	IEC 60115-1 and 60115-4					
Climatic category (IEC 60068)	55/155/56					
Stability $\Delta R/R_{max.}$ after:	For tolerance 5%			For tolerance 1%		
Load	±5.0% +0.1Ω			±1.0% +0.1Ω		
Climatic tests	±3.0% +0.1Ω			±1.0% +0.1Ω		
Resistance to soldering heat	±1.0% +0.05Ω			±0.5% +0.05Ω		

(1) Maximum rated voltage is the limiting voltage

TECHNOLOGY

A homogeneous film of metal alloy is deposited on a high-grade ceramic body. After a helical groove has been cut in the resistive layer, tinned connecting wires of electrolytic copper or copper-clad iron are welded to the end-caps. The resistors are coated with a red, non-flammable lacquer, which provides electrical, mechanical and climatic protection. The coating is resistant to all cleaning solvents in accordance with MIL-STD-202, method 215 and IEC 60068-2-45.

MECHANICAL DATA

AXIAL STYLE

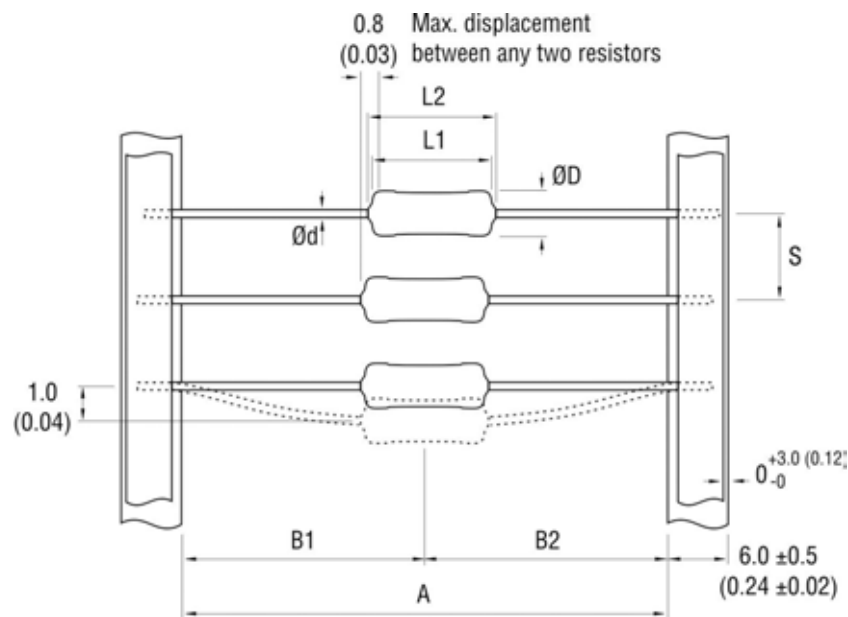

Fig. 1

Table 1. Mechanical Data.

PRODUCT	L1 max.	L2 max.	ØD max.	Ød	A	B1-B2 max.	S	WEIGHT gr/100 pcs.
PR01	6.5 (0.26)	8.5 (0.34)	2.5 (0.10)	0.58 ±0.05 Cu (0.023 ±0.002)	52.5 ±1.5 (2.07 ±0.06)	1.2 (0.05)	5.0 ±0.1 (0.20 ±0.01)	24.0
PR02	10.0 (0.40)	12.0 (0.48)	3.9 (0.16)	0.80 ±0.03 Cu (0.031 ±0.001)	52.5 ±1.5 (2.07 ±0.06)	1.2 (0.05)	5.0 ±0.1 (0.20 ±0.01)	52.0
				0.60 ±0.05 FeCu (0.024 ±0.002)				46.0
PR03	16.7 (0.66)	19.5 (0.77)	5.2 (0.21)	0.80 ±0.03 Cu (0.031 ±0.001)	63.0 ±1.5 (2.48 ±0.06)	1.2 (0.05)	10.0 ±0.1 (0.40 ±0.01)	120.0
				0.60 ±0.05 FeCu (0.024 ±0.002)				112.0

Dimensions unless specified in mm (inches)

MOUNTING

The resistors are suitable for processing on automatic insertion equipment, cutting and bending machines. A radial taped version economizes space on the PCB. The double kink style offers great advantages for manual insertion improving the mounting stability for the customer. They have a real snap in function to fix the resistor in PCB without weakening the connecting leads.

ELECTRICAL CHARACTERISTICS

DERATING

The power that the resistor can dissipate depends on the operating temperature.

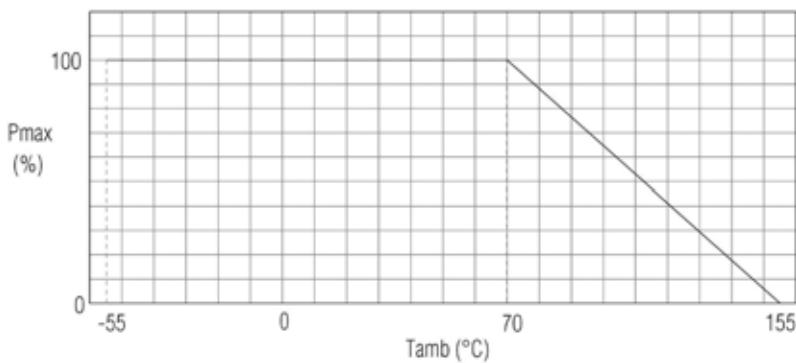

Fig. 2. Maximum dissipation (P_{max}) in percentage of rated power as a function of ambient temperature (T_{amb})

APPLICATION INFORMATION

PR01

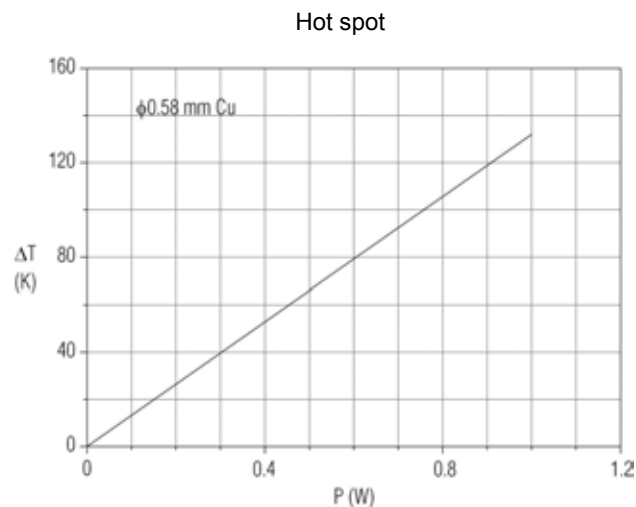

Fig. 3 - Hot spot temperature rise (ΔT) as a function of dissipated power.

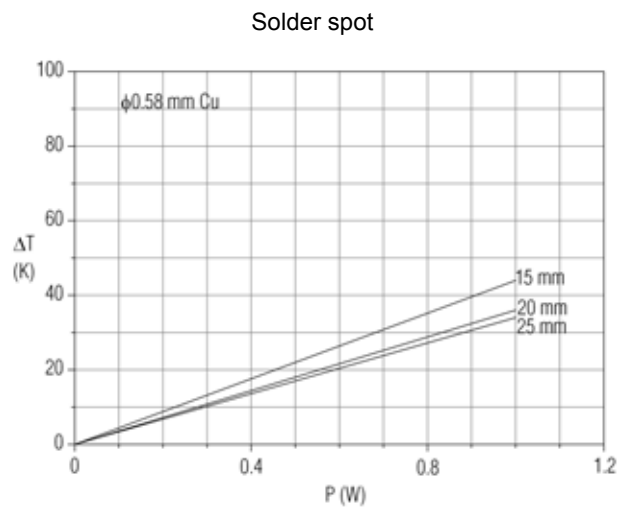

Fig. 4 - Temperature rise (ΔT) at the lead end (soldering point) as a function of dissipated power at various leads. Minimum distance from resistor body to PCB = 1mm

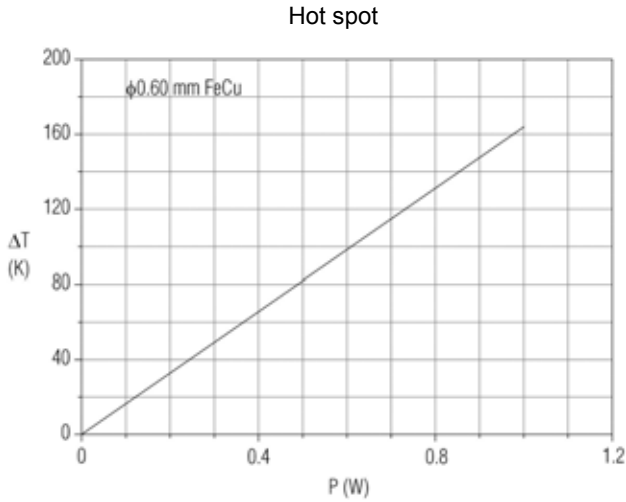

Fig. 5 - Hot spot temperature rise (ΔT) as a function of dissipated power.

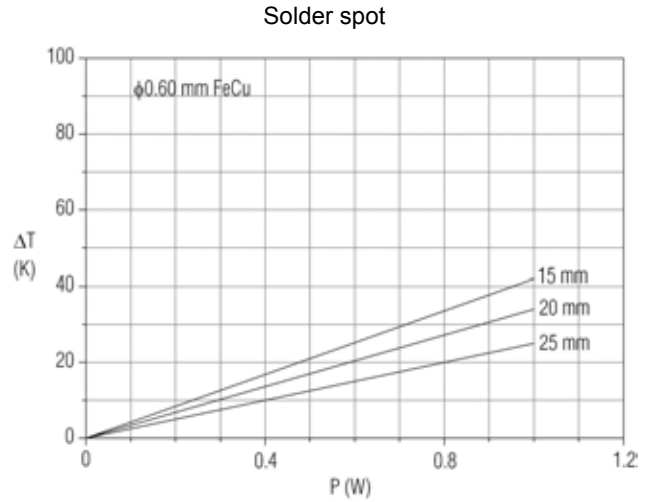

Fig. 6- Temperature rise (ΔT) at the lead end (soldering point) as a function of dissipated power at various leads. Minimum distance from resistor body to PCB = 1mm

PR02

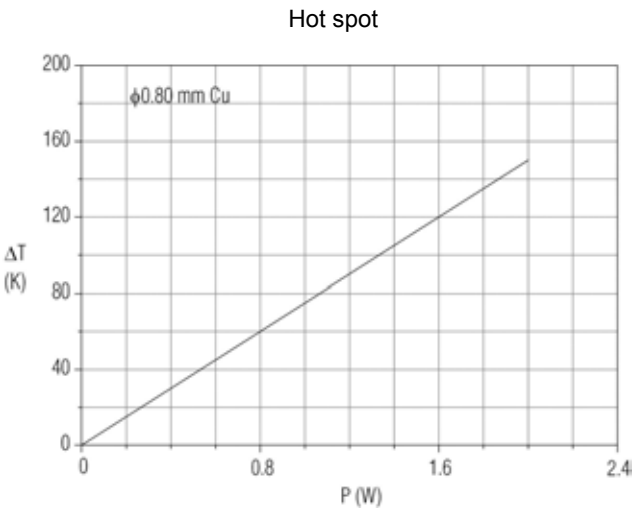

Fig. 7 - Hot spot temperature rise (ΔT) as a function of dissipated power.

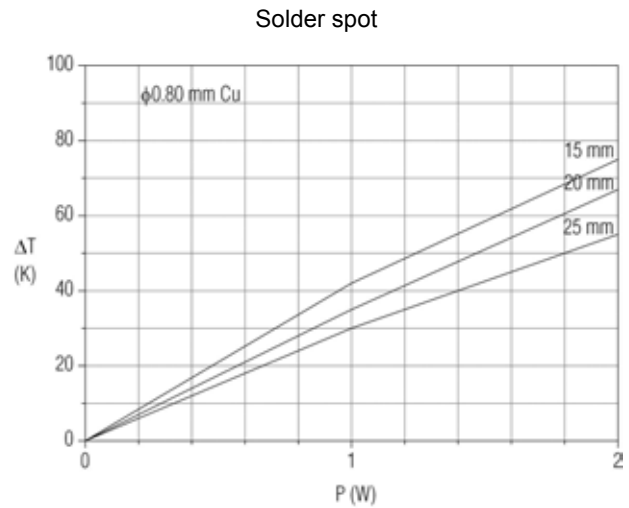

Fig. 8 - Temperature rise (ΔT) at the lead end (soldering point) as a function of dissipated power at various leads. Minimum distance from resistor body to PCB = 1mm

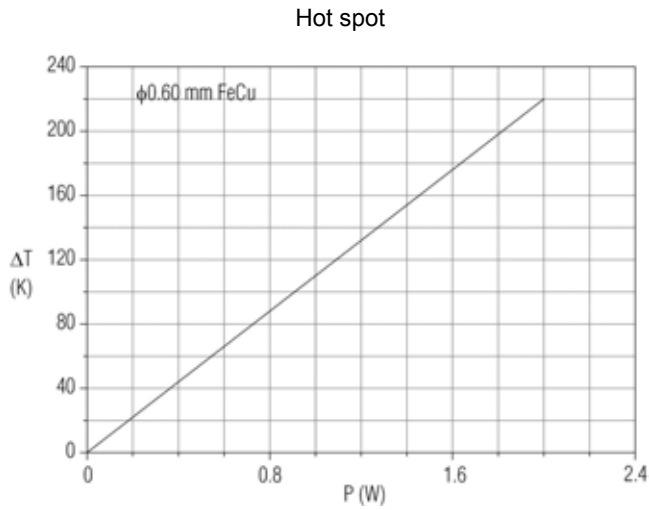

Fig. 9 - Hot spot temperature rise (ΔT) as a function of dissipated power.

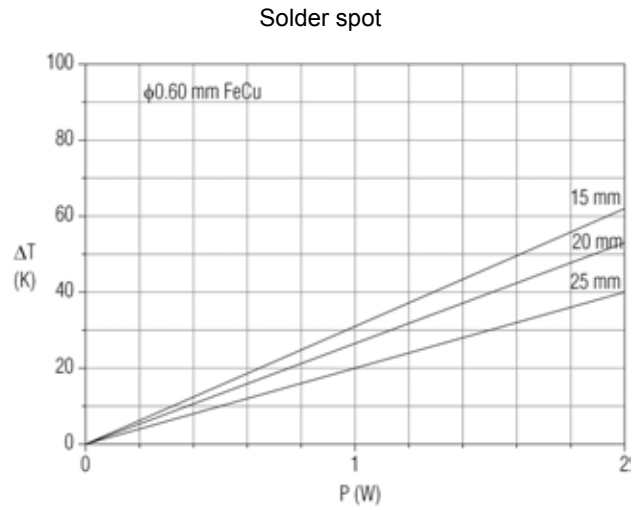

Fig. 10 - Temperature rise (ΔT) at the lead end (soldering point) as a function of dissipated power at various leads. Minimum distance from resistor body to PCB = 1mm

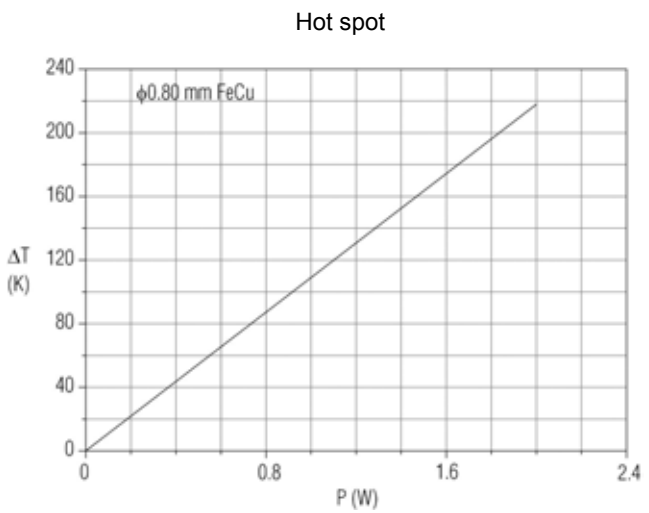

Fig. 11 - Hot spot temperature rise (ΔT) as a function of dissipated power.

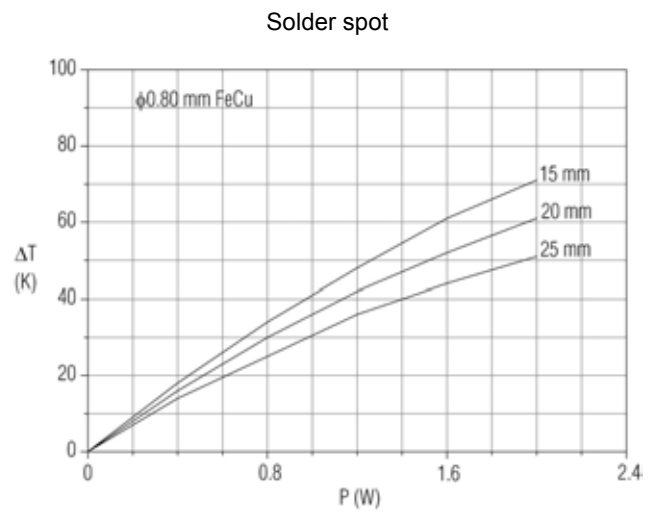

Fig. 12 - Temperature rise (ΔT) at the lead end (soldering point) as a function of dissipated power at various leads. Minimum distance from resistor body to PCB = 1mm

PR03

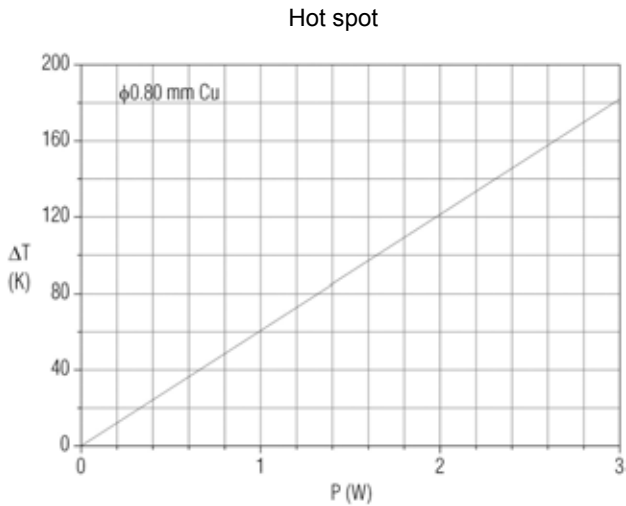

Fig. 13 - Hot spot temperature rise (ΔT) as a function of dissipated power.

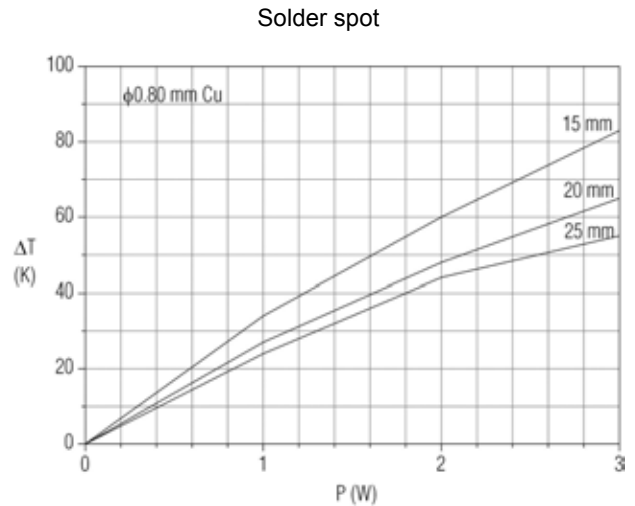

Fig. 14 - Temperature rise (ΔT) at the lead end (soldering point) as a function of dissipated power at various leads. Minimum distance from resistor body to PCB = 1mm

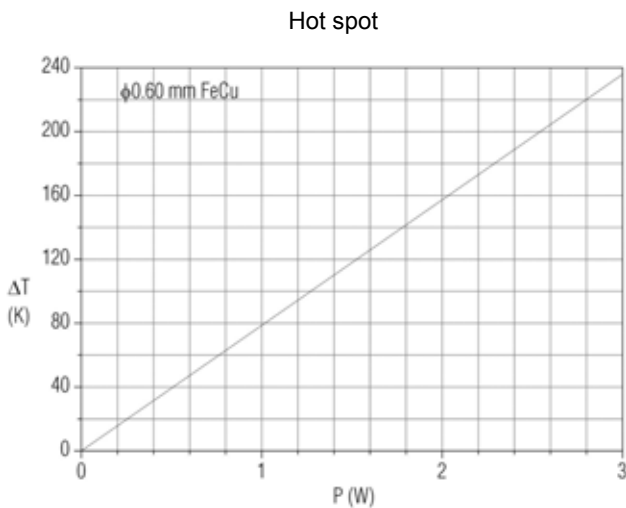

Fig. 15 - Hot spot temperature rise (ΔT) as a function of dissipated power.

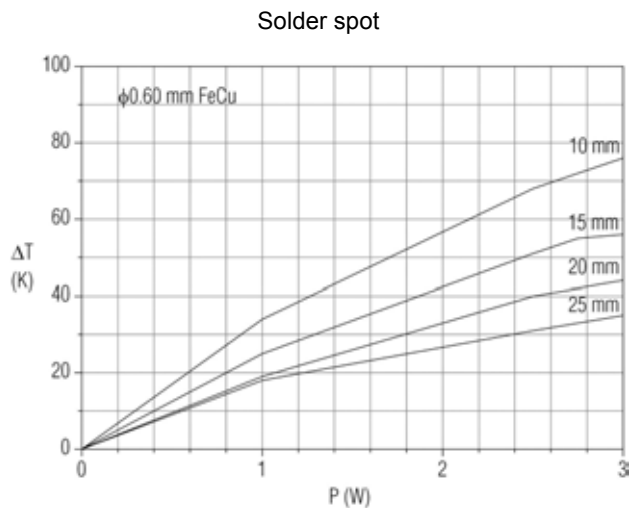

Fig. 16 - Temperature rise (ΔT) at the lead end (soldering point) as a function of dissipated power at various leads. Minimum distance from resistor body to PCB = 1mm

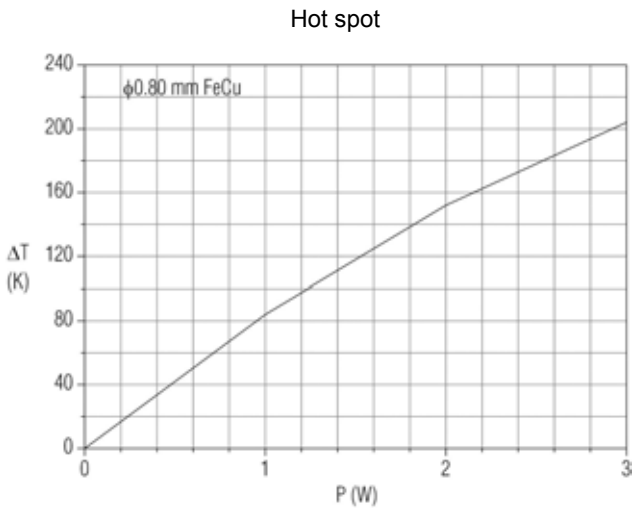

Fig. 17 - Hot spot temperature rise (ΔT) as a function of dissipated power.

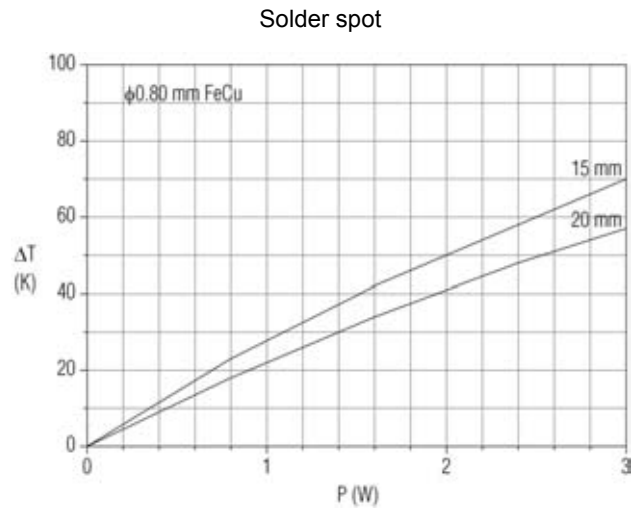

Fig. 18 - Temperature rise (ΔT) at the lead end (soldering point) as a function of dissipated power at various leads. Minimum distance from resistor body to PCB = 1mm

PULSE LOADING CAPABILITIES

PR01

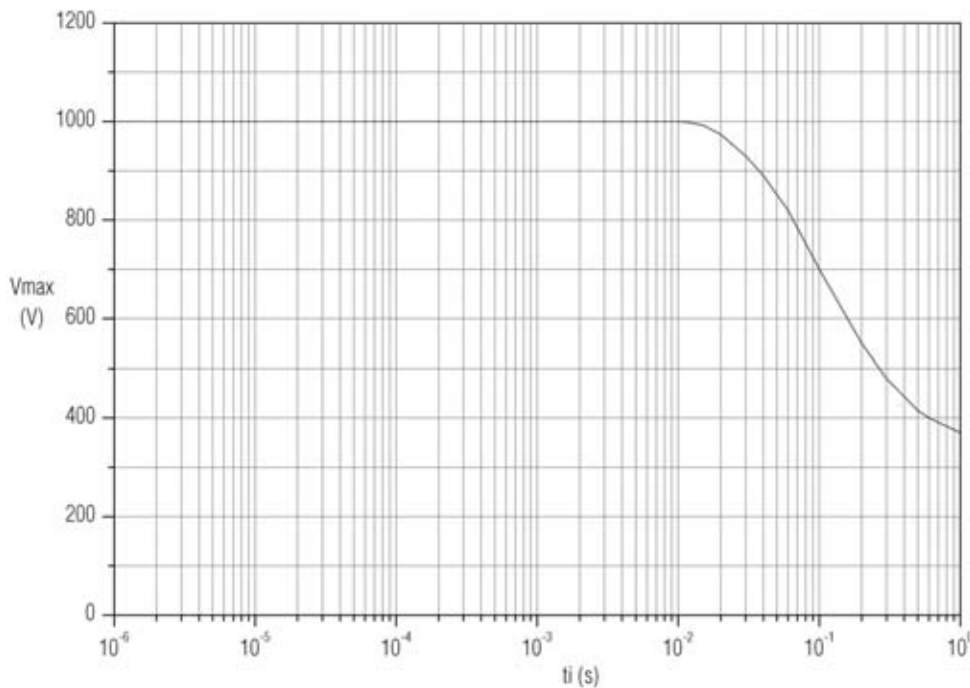

Fig. 19 - Pulse on a regular basis, maximum permissible peak pulse voltage (V_{max}) as a function of pulse duration (t_i)

PR

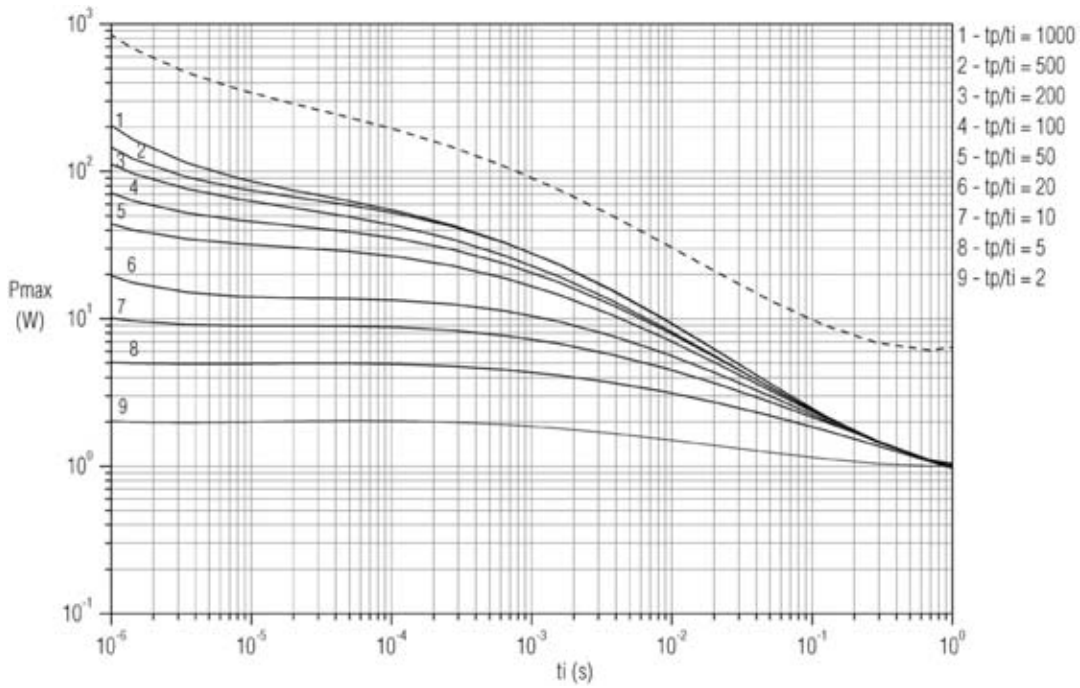

Fig. 20 - Pulse on a regular basis, maximum permissible peak pulse power (P_{max}) as a function of pulse duration (t_i)

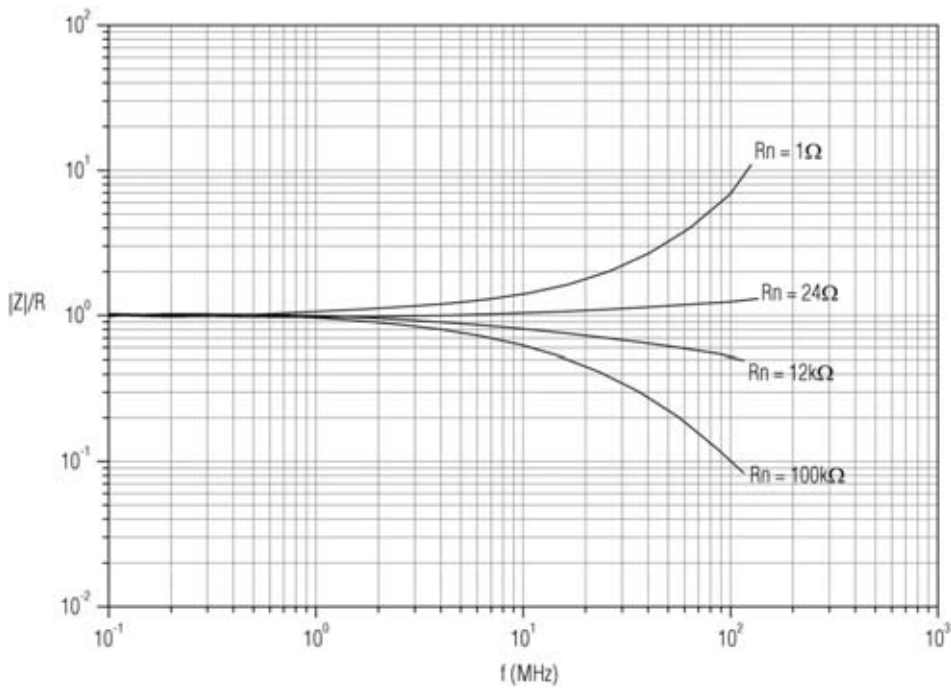

Fig. 21 - Impedance as a function of applied frequency

PR

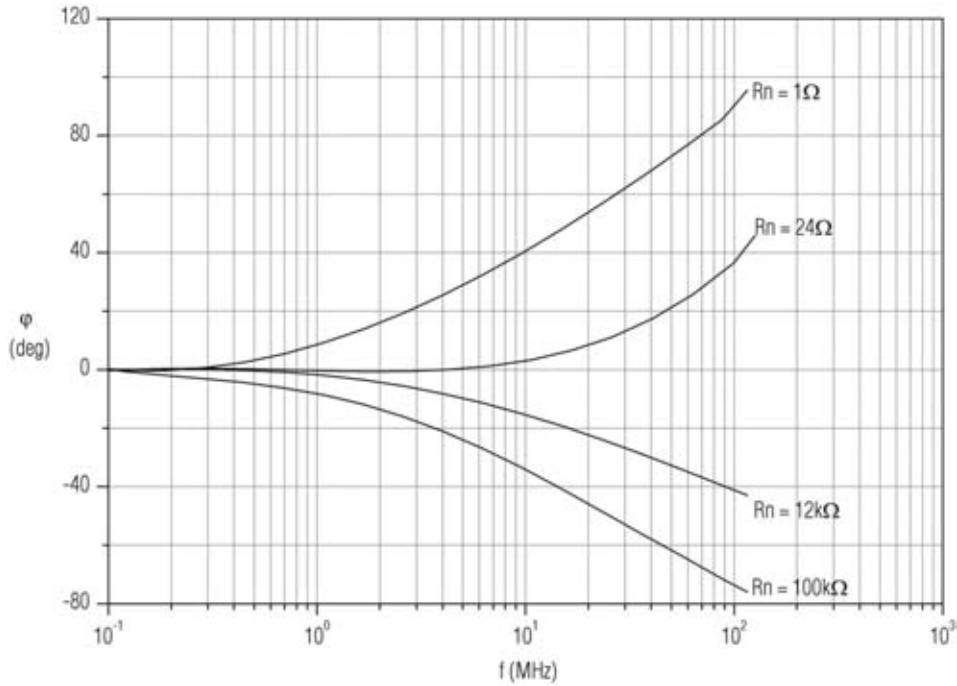
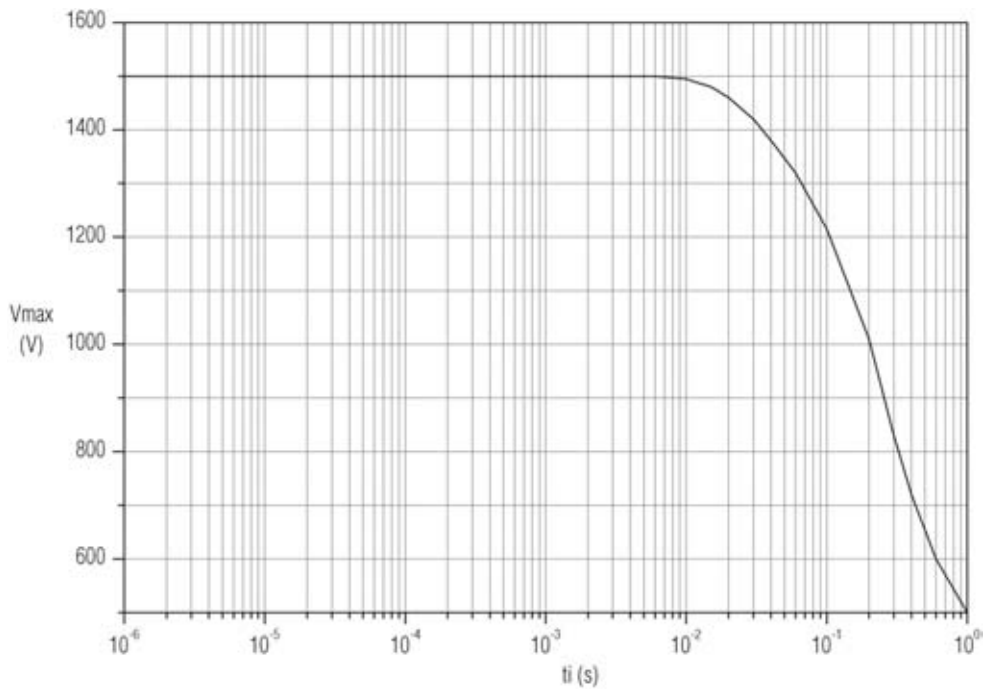

Fig. 22 - Phase angle as a function applied frequency

PR02



PR

Fig. 23 - Pulse on a regular basis, maximum permissible peak pulse voltage (V_{max}) as a function of pulse duration (t_i)

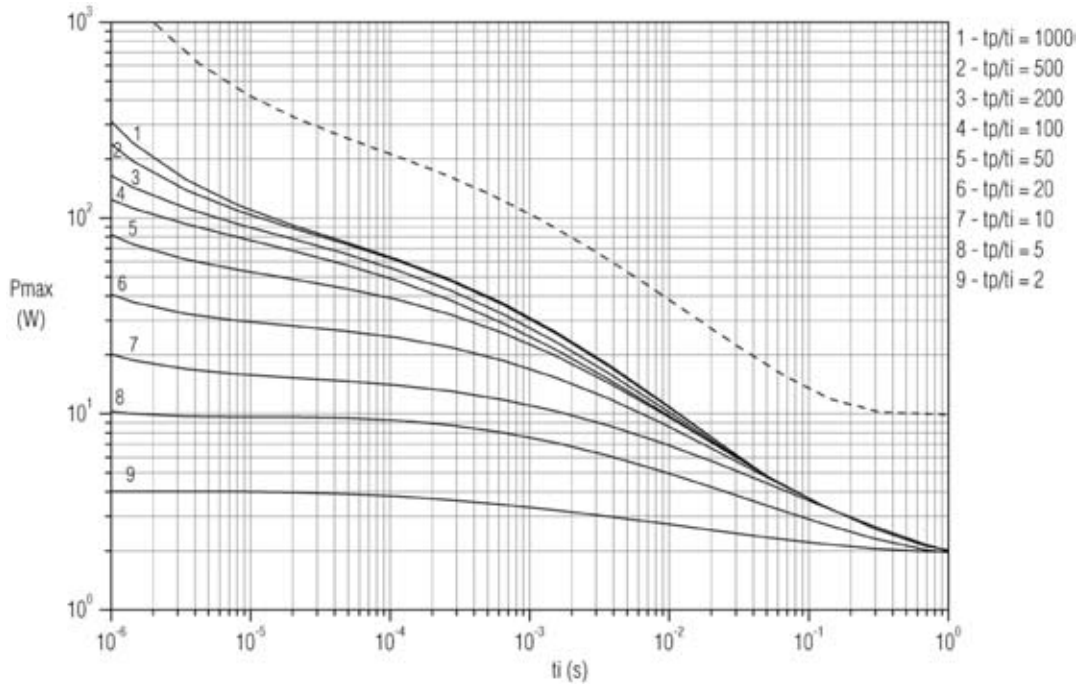

Fig. 24 - Pulse on a regular basis, maximum permissible peak pulse power (P_{max}) as a function of pulse duration (t_i)

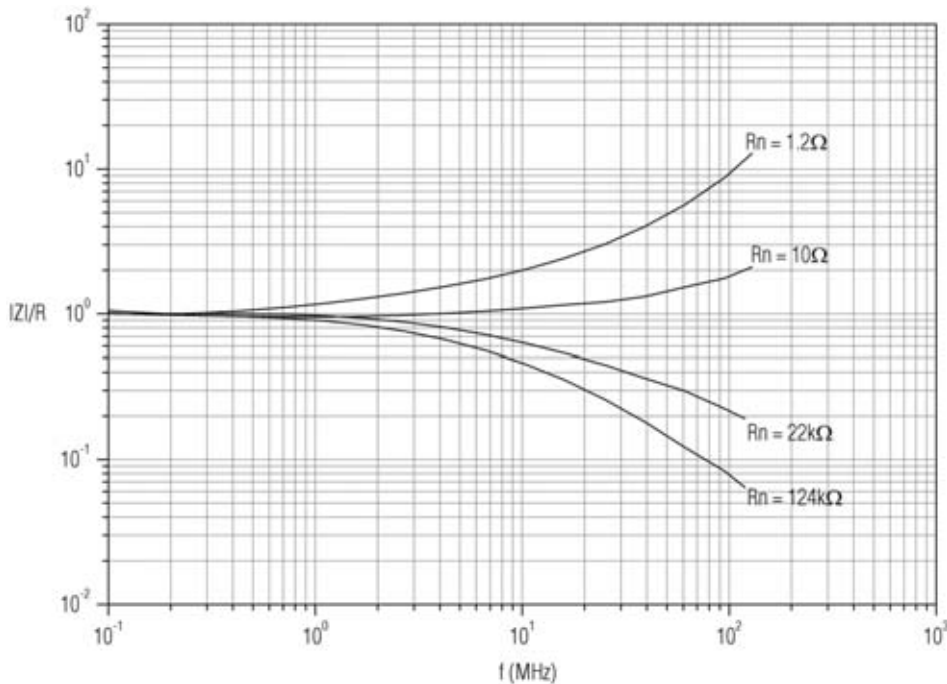

Fig. 25 - Impedance as a function of applied frequency

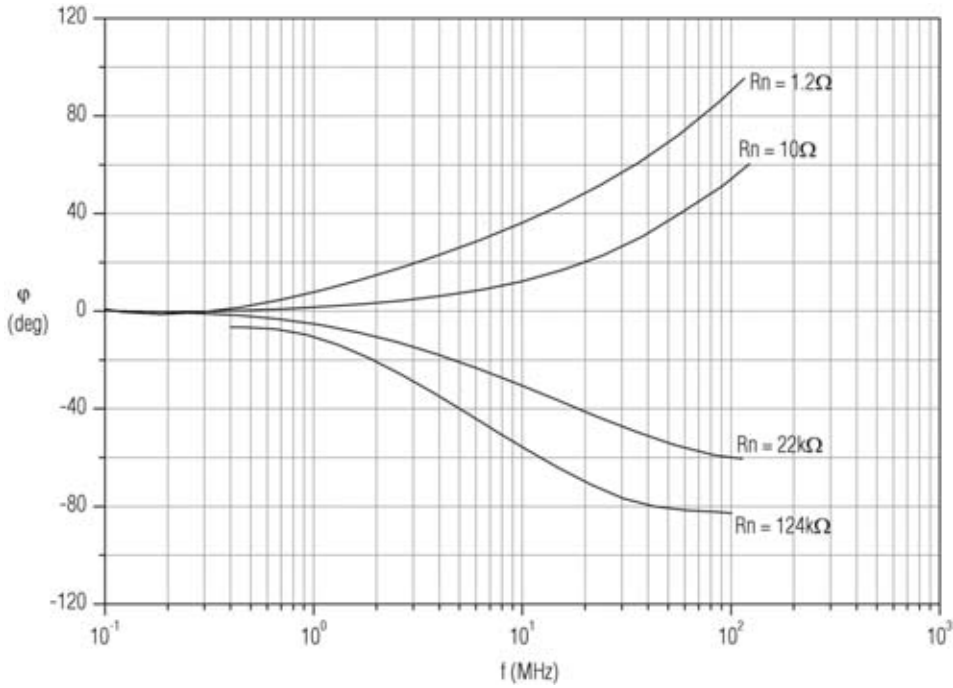

Fig. 26 - Phase angle as a function applied frequency

PR03

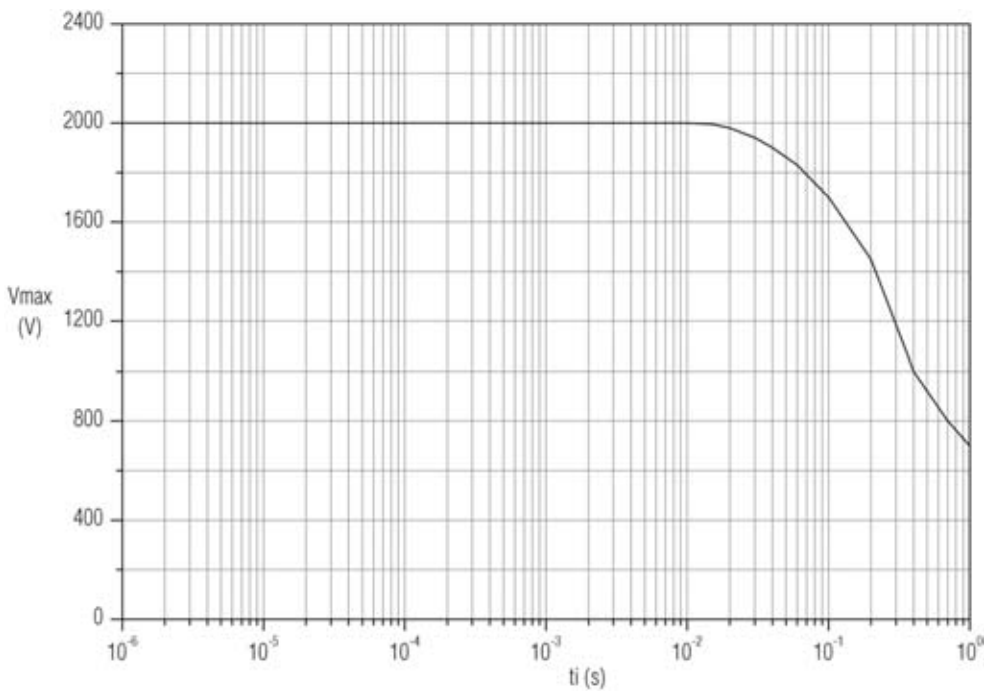

Fig. 27 - Pulse on a regular basis, maximum permissible peak pulse voltage (V_{max}) as a function of pulse duration (t_i)

PR

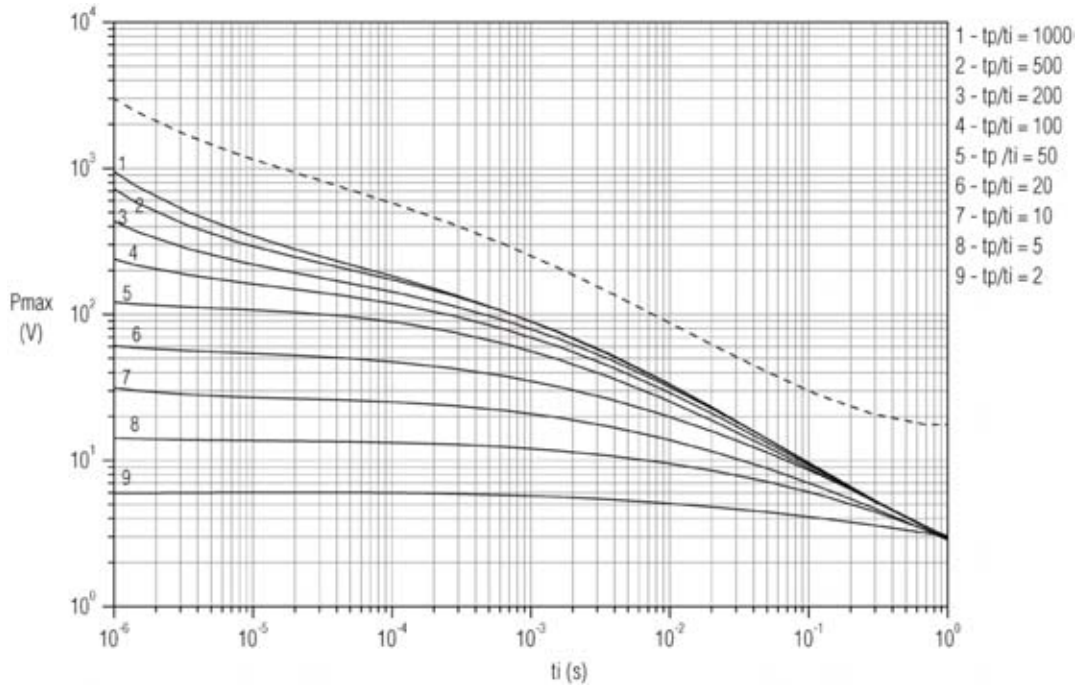

Fig. 28 - Pulse on a regular basis, maximum permissible peak pulse power (P_{max}) as a function of pulse duration (t_i)

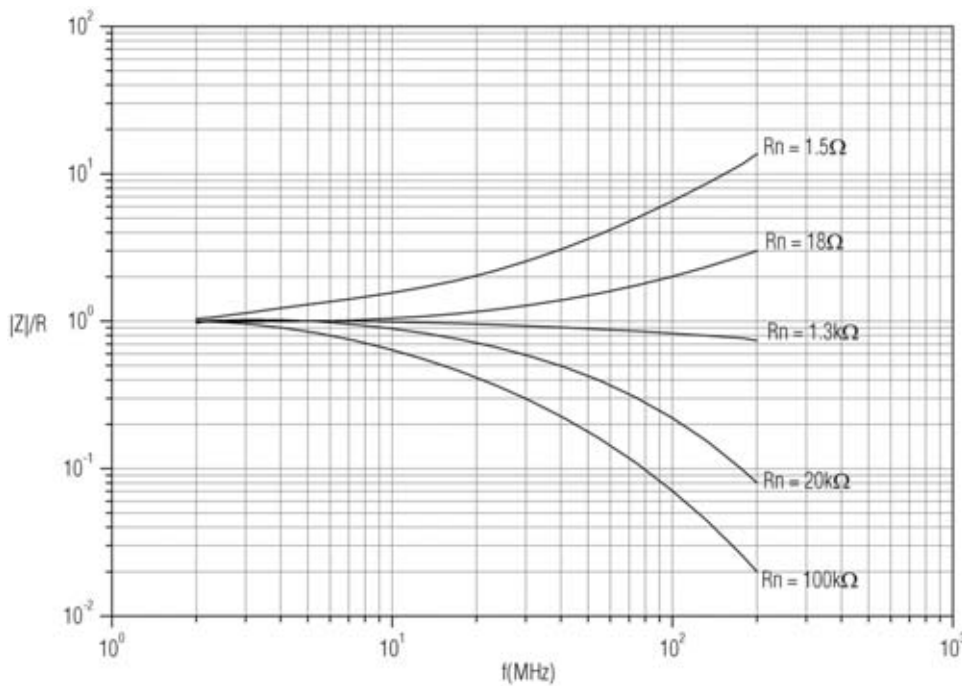

Fig. 29 - Impedance as a function of applied frequency

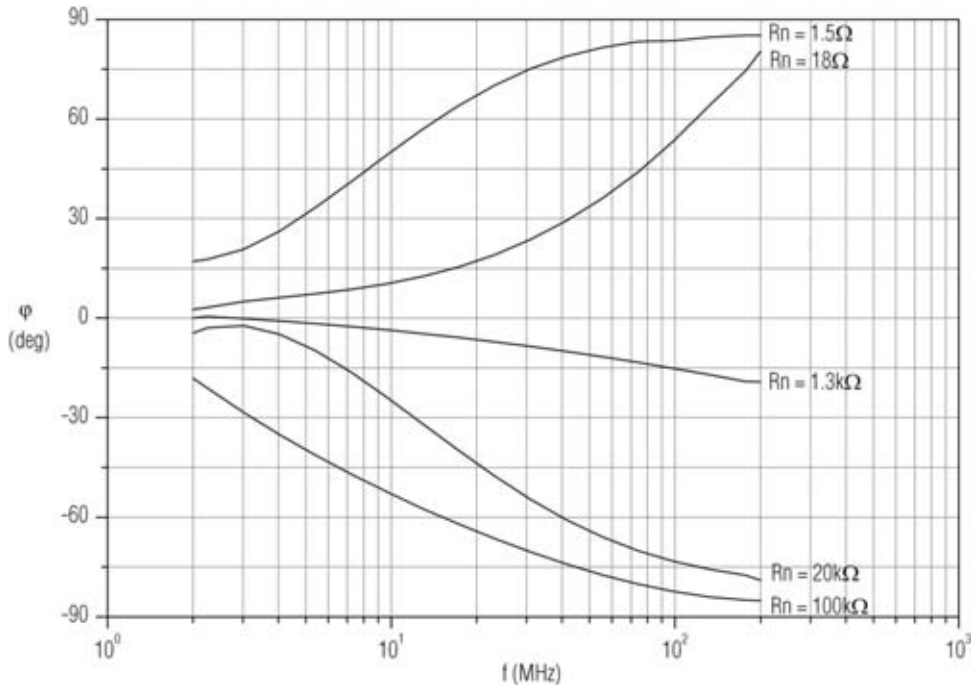

Fig. 30 - Phase angle as a function applied frequency

MARKING

The nominal resistance and tolerance are marked on the resistor using four or five colored bands in accordance with IEC publication 60062 “Color code for fixed resistors”. Standard values of nominal resistance are taken from the E24/E96 series for resistors with a tolerance of ±5% or ±1%. The values of the E24/E96 series are in accordance with IEC publication 60063.

ORDERING INFORMATION

Table 2. Ordering code.

PRODUCT	TOLERANCE	ORDERING CODE	TAPING	LEAD Ø	PACKAGING	QUANTITY pcs.
PR01	±5%	2306 197 53xxx	52.5 (2.07)	0.58 Cu (0.023)	AMMOPACK	1000
		2322 193 14xxx			AMMOPACK	5000
		2306 197 23xxx			REEL	5000
	±1%	2306 191 5xxxx			REEL	5000
		2322 196 1xxxx			AMMOPACK	5000
		2306 191 2xxxx			AMMOPACK	5000
					AMMOPACK	1000

PR

PRODUCT	TOLERANCE	ORDERING CODE	TAPING	LEAD Ø	PACKAGING	QUANTITY pcs.
PR02	±5%	2306 198 23xxx	52.5 (2.07)	0.80 Cu (0.031)	REEL	5000
		2306 198 53xxx			AMMOPACK	1000
		2322 194 54xxx		AMMOPACK	1000	
	±1%	2322 197 1xxxx		0.80 Cu (0.031)	AMMOPACK	1000
		2306 192 5xxxx		REEL	5000	
PR03	±5%	2322 195 14xxx	63.0 (2.48)	0.60 FeCu (0.024)	AMMOPACK	500
		2322 195 54xxx		0.80 Cu (0.031)	AMMOPACK	500
	±1%	2306 199 6xxxx		0.80 Cu (0.031)	AMMOPACK	500

Dimensions unless specified in mm (inches)
Check "**Formed leads**" specification to see related part-numbers

Table 3. Last digit of ordering code

RESISTANCE DECADE (5%)	RESISTANCE DECADE (1%)	LAST DIGIT
1 - 9.1 Ω	4.99 - 9.76 Ω	8
10 - 91 Ω	10 - 97.6 Ω	9
100 - 910 Ω	100 - 976 Ω	1
1 - 9.1 kΩ	1 - 9.76 kΩ	2
10 - 91 kΩ	10 - 97.6 kΩ	3
100 - 910 kΩ	100 - 976 kΩ	4
1 MΩ	1 MΩ	5

The resistors have a 12 digit ordering code starting with 2306 or 2322. The next 5 digits indicate the resistor type and packaging see table 2.

For 5% tolerance the last 3 digits indicate the resistance value:

- The first 2 digits indicate the resistance value;
- The last digit indicates the resistance decade in accordance with table 3.

For 1% tolerance the last 4 digits indicate the resistance value:

- The first 3 digits indicate the resistance value;
- The last digit indicates the resistance decade in accordance with table 3.

Example:

PR01, 150Ω, ±5%, taping distance 52.5mm, ammopack 1000pcs is **2306 197 53151**

NAFTA ORDERING INFORMATION

Table 4. NAFTA ordering code.

PRODUCT	TOLERANCE	NAFTA ORDERING CODE	TAPING	LEAD Ø	PACKAGING	QUANTITY pcs.
PR01	±5%	5073NWxxxxxJ12AFX	52.5 (2.07)	0.58 Cu (0.023)	REEL	5000
		5073NWxxxxxJA8AFX			AMMOPACK	1000
		5073NWxxxxxJ18AFX			AMMOPACK	5000
	±1%	5073NWxxxxxF18AF5			AMMOPACK	5000
		5073NWxxxxxFA8AF5			AMMOPACK	1000
		5073NWxxxxxF12AF5			REEL	5000

PR

PRODUCT	TOLERANCE	NAFTA ORDERING CODE	TAPING	LEAD Ø	PACKAGING	QUANTITY pcs.
PR02	±5%	5083NWxxxxxJA8AFX	52.5 (2.07)	0.80 Cu (0.031)	AMMOPACK	1000
		5083NWxxxxxJ12AFX			REEL	5000
		5083NWxxxxxJA8AFXF06		AMMOPACK	1000	
	±1%	5083NWxxxxxFA8AF5		0.80 Cu (0.031)	AMMOPACK	1000
		5083NWxxxxxF12AF5		REEL	5000	
PR03	±5%	5093NWxxxxxJA8AFX	63.0 (2.48)	0.80 Cu (0.031)	AMMOPACK	500
		5093NWxxxxxJA8AFXF06		0.60 FeCu (0.024)	AMMOPACK	500
	±1%	5093NWxxxxxFA8AF5		0.80 Cu (0.031)	AMMOPACK	500
					AMMOPACK	500

Dimensions unless specified in mm (inches)

Table 5. Examples of the ohmic value.

VALUE	5 DIGITS
1 Ω	1R000
10 Ω	10R00
100 Ω	100R0
1 kΩ	1K000
10 kΩ	10K00
100 kΩ	100K0
1 MΩ	1M000

The ohmic value in the NAFTA ordering code (see table 4) is represented by the “xxxxx” in the middle of the above ordering code. Table 5 gives some examples on how to use these 5 digits.

Example:

PR01, 1000Ω, ±5%, taping distance 52.5mm, ammpack 500 pcs is **5073NW1K000J18AFX**

PACKAGING

TAPE IN AMMOPACK

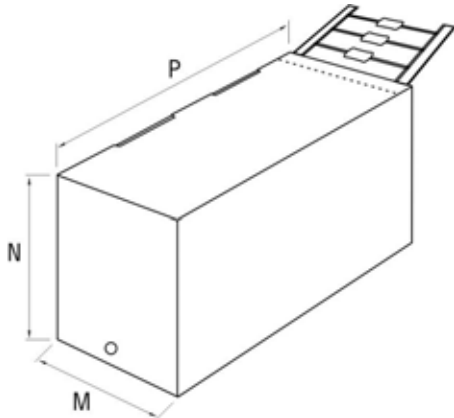

Table 6. Ammpack.

PRODUCT	TAPING	M	N	P	QUANTITY (pcs)
PR01	52.5 ±1.5 (2.07 ±0.06)	82 (3.3)	28 (1.2)	262 (10.4)	1000
		78 (3.1)	125 (4.9)	260 (10.3)	5000
PR02	52.5 ±1.5 (2.07 ±0.06)	78 (3.1)	60 (2.4)	262 (10.4)	1000
PR03	63.0 ±1.5 (2.48 ±0.06)	86 (3.4)	66 (2.6)	260 (10.3)	500

Dimensions unless specified in mm (inches)

TAPE ON REEL

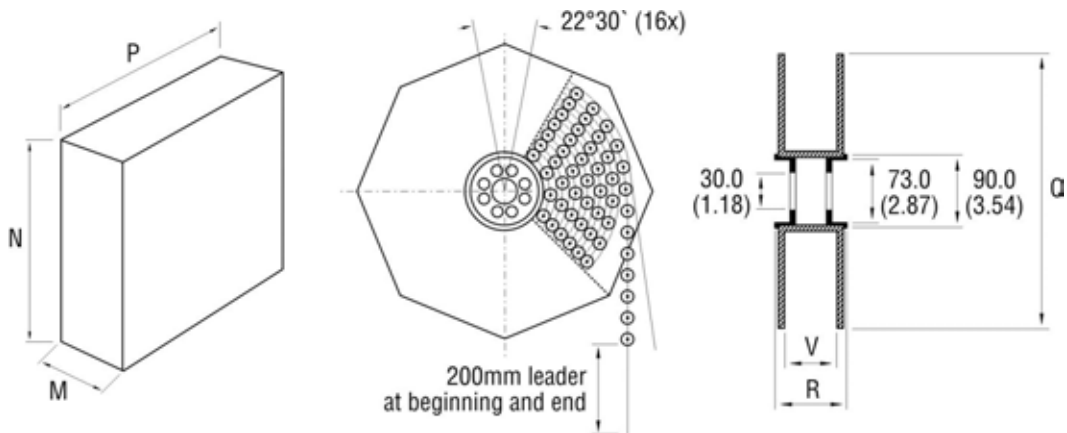

Table 7. Reel.

PRODUCT	TAPING	M	N	P	Q	V	R	QUANTITY pcs
PR01	52.5 ±1.5 (2.07 ±0.06)	92 (3.7)	311 (12.3)	311 (12.3)	305 (12.1)	75 (3.0)	86 (3.4)	5000
PR02	52.5 ±1.5 (2.07 ±0.06)	92 (3.6)	361 (14.3)	361 (14.3)	355 (14.0)	75 (2.9)	86 (3.4)	5000

Dimensions unless specified in mm (inches)

PR

TESTS AND REQUIREMENTS

Essentially all tests are carried out in accordance with the schedule of IEC publications 60115-1, category 55/155/56 (rated temperature range -55 to +155°C; damp heat, long term, 56 days and along the lines of IEC publications 60068-2); "Recommended basic climatic and mechanical robustness testing procedure for electronic components" and under standard atmosphere conditions according to IEC 60068-1 subclasse 5.3, unless otherwise specified. In some instances deviations from IEC applications were necessary for our specified method.

Table 8. Test and requirements.

IEC 60115-1 CLAUSE	IEC 60068-2 TEST METHOD	TEST	PROCEDURE	REQUIREMENTS	
				Tolerance 5%	Tolerance 1%
4.6.1.1	-	Insulation resistance	500 V (DC) during 1 minute; V-block method.	$R_{ins\ min} 10^4\ M\Omega$	
4.7	-	Voltage proof on insulation	500 V (RMS) during 1 minute, V-block method.	No breakdown or flashover	
4.8	-	Temperature coefficient	Between -55 °C and +155 °C	$\pm 250\ ppm/^{\circ}C$	
4.16	21(U)	Robustness of terminations:		No damage $\Delta R/R_{max} \pm 0.5\% + 0.05\ \Omega$	
4.16.2	21(Ua1)	Tensile all samples	Load 10 N, 10s		
4.16.3	21(Ub)	Bending half number of samples	Load 5 N, 4x90°		
4.16.4	21(Uc)	Torsion other half of samples	3x360° in opposite directions		
4.17	20(Ta)	Solderability (after ageing)	16 h at 155 °C; immersed in flux 600, leads immersed 2 mm for 2 ±0.5 s in a solder bath at 235 ±5 °C	Good tinning (≥ 95% covered) No damage	
4.18	20(Tb)	Resistance to soldering heat	Thermal shock: 3 s; 350 ±10 °C; 6 mm from body	$\Delta R/R_{max} \pm 1.0\% + 0.05\ \Omega$	$\Delta R/R_{max} \pm 0.5\% + 0.05\ \Omega$
4.19	14(Na)	Rapid change of temperature	30 minutes at - 55 °C and 30 minutes at +155 °C; 5 cycles	No visual damage	
				$\Delta R/R_{max} \pm 1.0\% + 0.05\ \Omega$	$\Delta R/R_{max} \pm 0.5\% + 0.05\ \Omega$
4.22	6(Fc)	Vibration	Frequency 10 to 500 Hz, displacement 1.5mm or acceleration 10g; three directions; total 6 hours (3x2 h)	No damage $\Delta R/R_{max} \pm 0.5\% + 0.05\ \Omega$	

IEC 60115-1 CLAUSE	IEC 60068-2 TEST METHOD	TEST	PROCEDURE	REQUIREMENTS	
				Tolerance 5%	Tolerance 1%
4.23		Climatic sequence:		$R_{ins\ min} 10^3\ M\Omega$	
4.23.2	2(Ba)	Dry heat	16 h; 155 °C		
4.23.3	30(Db)	Damp heat (accelerated) 1 st cycle	24 h; 25 °C to 55 °C; 90 to 100% RH		
4.23.4	1(Aa)	Cold	2 h; - 55 °C		
4.23.6	30(Db)	Damp heat (accelerated) remaining cycles	5 days; 25 °C to 55 °C; 90to 100% R.H.		
4.24	3(Ca)	Damp heat (steady state)	56 days; 40 °C; 90 to 95% R.H. loaded with 0.01Pn	$R_{ins\ min} 10^3\ M\Omega$	
				$\Delta R/R_{max}$ ±3.0% +0.05Ω	$\Delta R/R_{max}$ ±1.0% +0.05Ω
4.25.1	-	Endurance (at 70 °C)	1000 h loaded with Pn or V _{max} 1.5 h ON and 0.5 h OFF	$\Delta R/R_{max}$ ±5.0% +0.05Ω	$\Delta R/R_{max}$ ±1.0% +0.05Ω
4.29	45(Xa)	Component solvent resistance	Isopropyl alcohol followed by brushing in accordance with MIL STD 202	No visible damage	
See 2 nd amendment to IEC 60115-1		Pulse Load		See figs. 19, 20, 23, 24, 27 and 28	